

Static Magnetic Memory

By **MARSHALL KINCAID**

*Harvard Computation Laboratory
Harvard University
Cambridge, Mass.*

JOHN M. ALDEN

*New Products Director
Alden Products Co.
Brockton, Mass.*

and

ROBERT B. HANNA

*Technical Sales
Alden Products Co.
Brockton, Mass.*

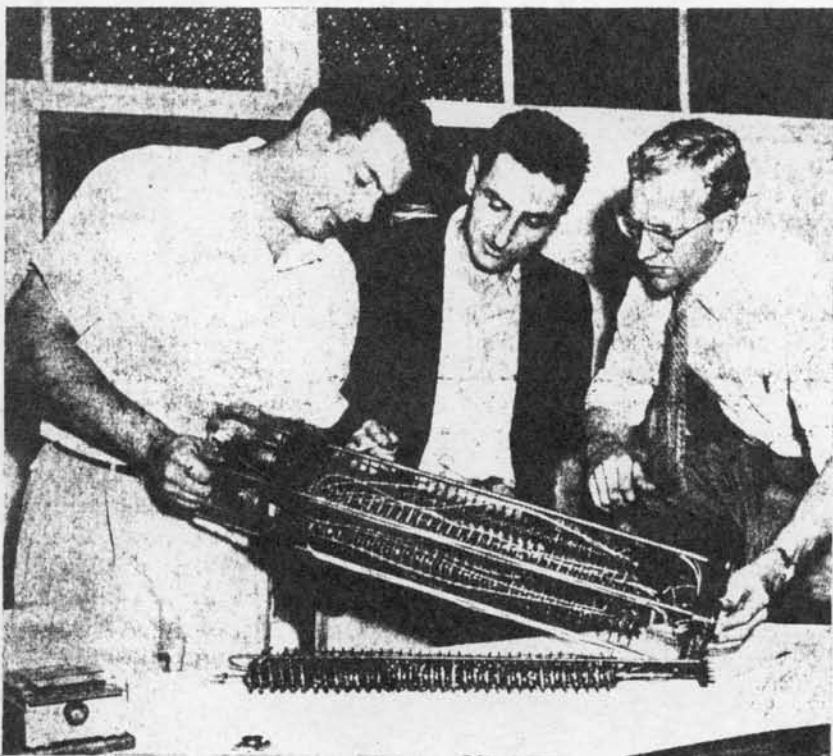

Prototype model of a 100-core static magnetic memory unit for use in the Mark IV computer at Harvard Computation Laboratory is composed of four vertically stacked banks of magnetic cores

LARGE-SCALE digital calculating machines have made many valuable contributions to fields in which the information handled is both extensive and complex. Typical applications have involved the solution of complex engineering and mathematical problems, such as the evaluation of Fourier series, the numerical solution of differential equations, and the solution of linear systems.

The machines used in this type of large-scale information handling are characterized by high cost; in many cases, they represent expenditures of one-quarter of one

million dollars.

Progress made in this field has stimulated thinking concerning the possible application of less costly electronic computers to problems of information control and data-handling encountered in daily operation of business and industry. The high level of interest is indicated by the suggested application of computers to automatic continuous auditing, accounting and inventory systems, and automatic vending machines.

Less costly, less complex and practical machines for this type of business and industrial use certainly do not have to await ultimate

perfection of ultrahigh-speed techniques. Operating speeds of the order of 30 kc, entirely practical at the present time, are sufficiently high to make machines of this type valuable. Furthermore, many of the necessary techniques and components for the design and manufacture of machines for medium-speed business use are either now available or becoming available.

Magnetic Material

One of the newest components, called the Static Magnetic Memory, should permit substantial advances to be made in the improvement of computing machinery for business and industrial applications. The development of this device is an outgrowth of a discovery by German scientists during the last war of permanorm 5000Z, a material that has a rectangular hysteresis loop of low coercive force. A similar material known as Delta-max is now produced in this country by Allegheny Ludlum Steel Corp. Howard Aiken of the Harvard Computation Laboratory foresaw the possible use of such a material, because of its two stable-state characteristics, as a means of information storage in large scale digital computers. His basic idea has been implemented and carried out during the past two years by the work of Dr. An Wang and Dr. Way Dong Woo.

The device provides permanent information storage comparable to magnetic drum storage, but independent of mechanical mechanisms. A variable information handling rate is available ranging from zero to 30,000 pulses per second, with probable future increases in the present upper limit. Pulse storage is provided without

for Low-Cost Computers

Magnetic material having a rectangular hysteresis loop provides information storage independent of mechanisms, variable data-handling rate up to 30,000 pps and pulse storage without power. Aids in design of computing machines for business use

power being required.

The static magnetic memory operates essentially as a magnetic trigger pair, which requires no vacuum tubes to maintain position. The trigger-pair action depends on the state of the core material being represented by a point at either the top or bottom of the hysteresis loop, as in Fig. 1. This necessitates the use of a core material whose hysteresis characteristics approximate the ideal square loop, shown in Fig. 1.

Hysteresis Curve

The hysteresis curve of Deltamax, Fig. 2, shows that this material is quite suitable for this application, due to the rectangularity of its loop. Because of the flat top and bottom of the loop, once the core is saturated in a given direction, further application of current pulses that tend to saturate the iron in the same direction will cause no further change in flux, and therefore will not produce any pulses in the output winding of the core. However, the first current pulse of an opposite polarity that occurs will cause an extremely large change in flux, thereby producing a pulse in

the output winding. The presence or absence of a pulse is thus determined by the previous history of the iron core.

With several cores connected as in Fig. 3, the state of the preceding core can be transferred from that core to the next, provided suitable rectifiers are added to the basic circuit to prevent the backward flow of current. Rectifier 1 allows the current produced in the output winding of the first core to enter the input winding of the second core, and prevents any flux generated in the input winding of the second core from returning to the output winding of the first core.

Rectifier 2 allows all current provided by the output winding of the first core to enter the second core and provides a path for the current from input winding of the second core to be dissipated in the resistor instead of upsetting the first core. By alternately pulsing the advance windings of even and odd-numbered cores the state of any core relative to the hysteresis loop (Fig. 1) may be transferred to the succeeding core. Typical pulse patterns of this operation are shown in Fig. 4.

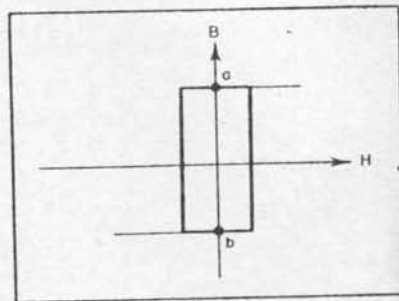

FIG. 1—Ideal hysteresis loop

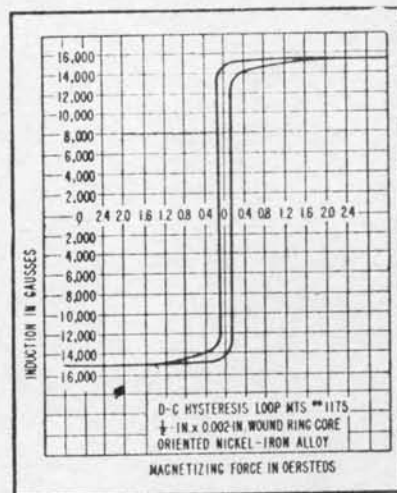
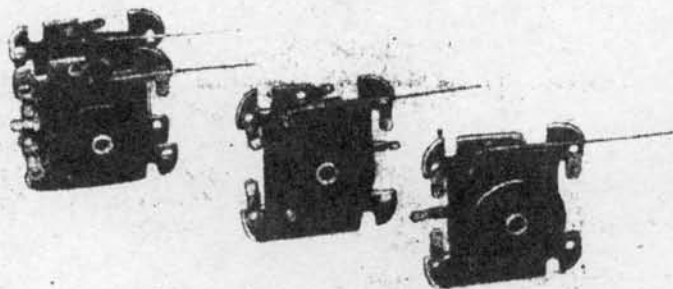

FIG. 2—Hysteresis loop of Deltamax core material



Single magnetic cores are shown in the center and at the right, at left is a pair of cores. The hollow rivets permit stacking

Magnetic tape, magnetic drums, acoustic delay lines and other devices all accomplish a similar storage function. In this device, after information has been once stored, the cessation of power leaves the stored information unaffected. Furthermore, signal regeneration is unnecessary, for the device can continually store and circulate the pulses without attenuation. Fundamentally, the static magnetic memory differs from functionally similar devices in that it accomplishes pulse storage by electrical means without

employing complex vacuum-tube circuits, in a manner completely independent of the mechanical operation found in some of the other storage devices.

The static magnetic memory device has already proved useful as a means of storing information, as a means of transferring information

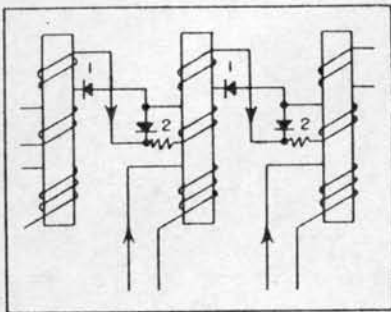

FIG. 3—Delay-line circuit of two cores per digit

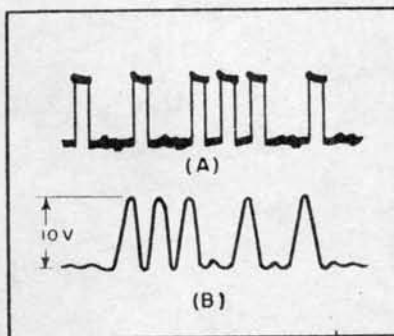

FIG. 4—Flux versus time curve in the two-core circuit. At (A), information 1010111010 is displayed at a rate of 2.5 kc. At (B), information 0011101010 is shown at 25 kc

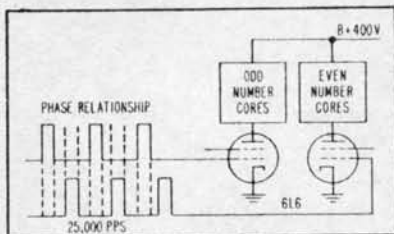

FIG. 5—Advance winding pulsing by means of tube plates. Even-numbered core advance windings are all in series

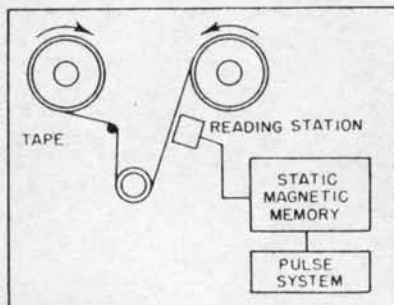

FIG. 6—Method of transferring high-speed pulses on magnetic tape to a slow-speed pulse system

between systems of different pulse rates, as a counter in which any configuration of pulses may be counted or circulated, and as a means of transferring information from serial form to parallel form, or vice versa.

Storing Information

Whenever a time delay of any length is necessary between incoming pulse information and its later use, this device can continuously cycle or dormant store the information pulses without attenuation until output is required. In its storage function it is particularly significant that the device requires no power to retain previously stored pulses.

Power interruptions or necessarily prolonged periods between input and output of pulsed commands or data thus do not impose limits on the storage function of the static magnetic memory for power is necessary only to pulse information in or out of the device.

One group is using these devices as a means of storing 16-digit decimal numbers. The number is determined by the presence or absence of a pulse. The static magnetic memory is involved in the relay circuit of a multiplier capable of obtaining a 46-digit product of two 23-digit factors. The equipment was constructed by the staff of the Computation Laboratory of Harvard University as an auxiliary to the IBM Automatic Sequence Controlled Calculator, usually known as the Mark I.

The single elements may also be assembled in such a manner that the two advancing windings are pulsed from the plates of tubes, thereby transferring the numbers in or out of a given register. A simplified schematic illustrating this arrangement is shown in Fig. 5. Any pentode type that will deliver 150 ma peak plate current will operate satisfactorily. At a lower repetition rate, however, more turns of wire may be added to each core and correspondingly smaller tubes may be used.

Systems of Different Pulse Rates

A second broad group of applications of the static magnetic memory involve its use as a transfer

medium between systems of different pulse input and output speeds. This means that the device operates essentially as a speed transformer. Pulse input speeds of the order of 25 kc in some cases might be of little value if output could not be effected at a much slower speed, as for example, to operate mechanical printing devices or telegraphic instruments. This function combined with its storing ability allows the coupling of medium-frequency pulsing systems to devices of much lower operating speeds and vice versa.

A system employing magnetic tape (Fig. 6) illustrates the value of a linking medium between systems of different pulse rates. While recording on the tape a pulse rate of 10 kc, for example, may be very desirable, yet output to typewriters, solenoids or relays is impractical at this speed. However, this process can be made entirely feasible by means of a rapid input pulsed into the static magnetic memory and pulsed out at the desired slower speed.

Conversely the same is true: a relatively slow input from punched cards or some mechanical source may be read out of the static magnetic memory at a higher speed appropriate to magnetic recording on tape. Wherever it is desirable to use a relatively high input speed to the device while a different output rate suitable for a mechanical operation is required later, (or the reverse of these conditions), this device can find many valuable applications.

Use as a Counter

The static magnetic memory provides a means of accurately recording pulses at rates up to 25,000 per second. In this application the device employs no complex vacuum-tube circuits, requires power only for circulation and none for storage of pulses, and imposes no restrictions because of inherent fragility. The unit may be applied to counting operations ranging from those using rapid electronic pulsing mechanisms to those of lower speed machine operations.

To be used in this manner the static magnetic memory uses as its input a single information pulse.

The number of advancing pulses that have been applied to the device is determined from the core location of the input pulse. For example, by using three units of 10 cores each and placing one pulse in each unit, the pulse in the first ring of 10 will operate a second ring of 10, which in turn can operate any other familiar counting device. An arrangement of this sort is shown in Fig. 7, in which an input of 25,000 pulses per second fed into a series of three units of 10 cores each operates a mechanical counting device at a rate up to 25 pulses per second.

Use of the static magnetic memory for counting purposes allows a peak counting rate of 25,000 pulses per second, in its present form. Any configuration may be cycled continuously by the device, and at this speed its value to decade counters, monitoring operations, and pulse control application in general is apparent.

Changing Information

An additional application of this device lies in its ability to change the form of input or output pulses. In certain instances, because of the particular circuit conditions involved, it is highly desirable for operation to be in either serial or parallel form. For example, large-scale digital computers utilize input information in both a serial and parallel manner. Furthermore, some means is necessary whereby the parallel output of a computer can be shifted to the serial form required if the information is to be recorded on magnetic tape. Hence the value of the device is its capability of changing input or output pulses from one form to the other.

By connecting gating circuits to every other core that makes every pulse obtainable through the unit (Fig. 8A) information may be introduced and transmitted in either a serial or parallel manner.

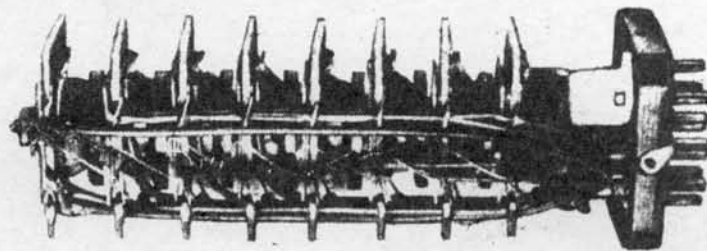

Complete eight-core unit mounted on a 20-pin plug-in base

A gating circuit for this purpose is shown in Fig. 8B. Since each core can have an output of approximately 10 volts, satisfactory operation of the circuit is accomplished by using a type 6AS6 tube. By the addition of special windings to the cores of the device, the output voltage can easily be increased to a magnitude of 30 volts. This is sufficient voltage to bias and fire a typical 2D21 thyatron in a reasonably short time, and leads to relay operation such as that used in the Harvard multiplier previously mentioned.

Production

A major problem in the manufacture of this device involved the development of special techniques and

methods for handling, processing and controlling the expensive and fragile core material. For example, difficulty was encountered in maintaining proper curvature in Delta-max strips 0.001-inch thick, so that the essential hysteretic character of the material would remain unaltered. In addition, inherent fragility of the material necessitated painstaking handling. For these reasons an almost shadowless lighting bench was designed and built, at which specialized assemblers work in rotating short periods.

Unit assembly is simplified and made rapid by the design of individual cores. A central tubular rivet in the individual unit allows them to be stacked about a central rod into lines of any feasible length, from a small 8-core unit up to 34 and 100 core banks. Adaptation to the particular circuit requirements thus has been anticipated, while ease of interconnection is provided by means of simple jumper connections between accessible solder terminals. The manufacturing design also incorporates the advantages of plug-in unit construction, by the addition of a 20-pin plug-in base.

The authors wish to acknowledge the valuable help and co-operation given by Howard Aiken, Director of the Harvard Computation Laboratory, Harvard University, Cambridge, Mass.

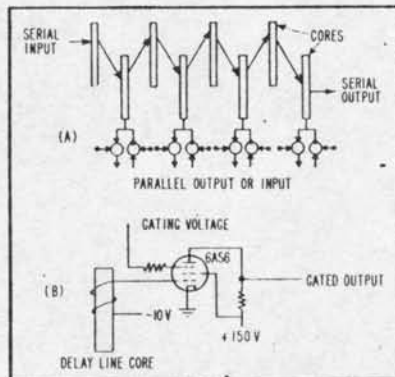

FIG. 8—Core connections for serial-parallel transformation, and delay-line output circuit for this purpose

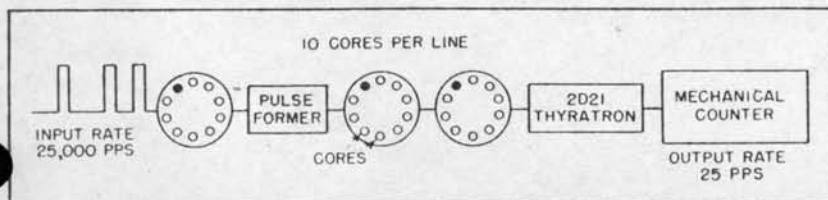

FIG. 7—Use of the magnetic memory device as a counter

BIBLIOGRAPHY

- An Wang and Way Dong Woo, Static Magnetic Storage and Delay Line, *Jour. App. Phys.* 21, 1, p 49, Jan. 1950.
- An Wang, Magnetic Triggers, *Proc. IRE*, 38, 6, June 1950.
- The Computation Laboratory, Harvard University, Cambridge, Mass. Progress Reports 1-10, "Investigations for Design of Digital Calculating Machinery." (Contract W 19-122-AC-24 between Harvard Univ. and U.S.A.F.)